

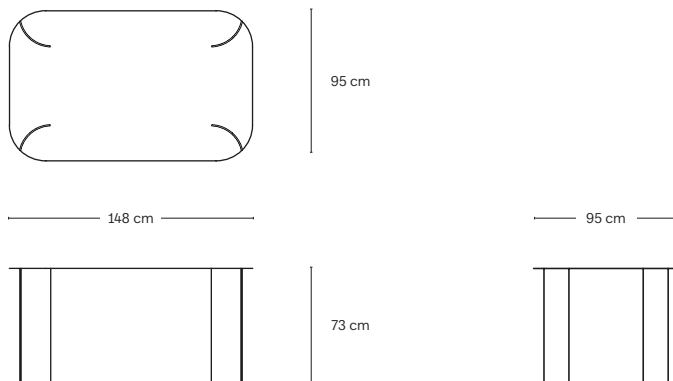

India Medium



Anno Year	Descrizione Description	Indoor/Outdoor		Design
2025	Tavolo Table	Indoor + Outdoor		Atelier Ferraro
Misure Dimensions	Peso Weight	Manifattura Manufacture	Materiali Materials	Colori disponibili Available colours
L 148 cm H 73 cm W 95 cm	80 kg	Saldatura a mano Handmade welding	Alluminio verniciato Painted aluminum	Monocolore Single Colour  Tutti i colori All colours

Verniciature
Paintworks

Indicazioni sedute
Seating indications

Verniciatura a polvere
Powder coating

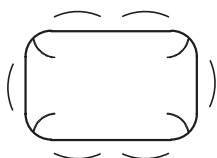

Verniciature e trattamenti Paintwork and treatment

VERNICIATURA A POLVERI

La verniciatura a polveri è un rivestimento a base di resine sintetiche passate in un forno ad alte temperature. La vernice polimerizzata crea uno strato aderente e resistente.

Manutenzione: pulizia con prodotti poco aggressivi.

POWDER COATING

Powder coating uses synthetic resins dried at high temperatures. The cured paint creates an adherent and durable coating.

Maintenance: cleaning with slightly aggressive products.

VERNICIATURA A SPRUZZO

La verniciatura a spruzzo è uno smalto acrilico a due componenti di elevata opacità. Viene stesa a mano ed essiccata a basse temperature.

Manutenzione: pulizia con prodotti poco aggressivi.

SPRAY PAINTING

Spray painting is a two-pack very matt acrylic enamel. It is hand spread and dried at low temperatures.

Maintenance: cleaning with slightly aggressive products.

ZINCATURA

Processo galvanico che crea un sottile strato di zinco che protegge il metallo dall'ossidazione. Processo utilizzato per prodotti a uso esterno. Si riveste infine con una verniciatura a polveri.

GALVANIZATION

The process of applying a protective zinc coating to prevent iron rusting. It is used for outdoor products. It is finally powder coated.

Materiali Materials

ACCIAIO

Lamiera di acciaio super mirror galvanizzata in due diverse versioni, cromo e oro 24 carati.

Manutenzione: pulizia con prodotti specifici per acciaio.

STEEL

Galvanized high gloss steel plate in 24-carat gold or chrome version.

Maintenance: cleaning with specific products for steel.

LAMIERA DI FERRO LAMINATA A CALDO*

La superficie di metallo può presentare imperfezioni e sfumature ogni volta differenti. Tale caratteristica non rappresenta un difetto ma è elemento intrinseco del materiale di uso industriale.

HOT ROLLED IRON PLATE*

The metal surface can show different imperfections and shadows. This is not a flaw to be fixed but the intrinsic feature of the material and its industrial usage.

Materiali su richiesta Materials on request

CORTEN*

Acciaio indicato per uso esterno grazie alla sua elevata resistenza alla corrosione. La sua caratteristica principale è la patina di ossido che gli conferisce la finitura effetto ruggine. Viene fornito già ossidato con trattamento a cera.

CORTEN*

Weathering steel for outdoor use thanks to its high resistance to corrosion. Its main feature is an oxide coat lending a rust-like finish. When furnished, it has been already oxidised with a wax treatment.

BRUNITURA

Trattamento che si ottiene esponendo il metallo ad acidi brunitori. Conferisce al metallo una finitura disomogenea. Protetto con trasparente.

BLACKENING

Treatment obtained by exposing the metal to blackening acidics to lend an irregular and dark finish. Transparent protection.

Note Notes

* Trattamento protettivo a cera d'api.

La cera d'api crea un sottile e delicato strato di protezione. Il trattamento viene effettuato manualmente tramite un panno sulla lamiera di ferro laminata a caldo e sul Corten.

Manutenzione: effettuare ceratura ogni 6 mesi. Pulizia con prodotti poco aggressivi.

* Beeswax protection treatment.

Beeswax creates a thin and delicate layer of protection. The treatment is carried out manually using a cloth on the hot worked iron plate and on Corten steel.

Maintenance: wax this surfaces every 6 months. Cleaning with slightly aggressive products.

Info generali General information

Tutti gli oggetti possono essere sviluppati su misura, sia per dimensione che finitura. Per qualsiasi info, contattateci. Tutti i pezzi sono numerati. Tutti gli oggetti di questo catalogo sono realizzati da Marco Ripa.

All items can be developed to measure, both in size and finish. For any information, please contact us. All items are numbered. All items in this catalogue are made by Marco Ripa.

Colori Opachi
Matt Colours

 Carta
Paper
Cod. 01
RAL 9016

 Liquirizia
Licorice
Cod. 02
RAL 9005

 Pesca
Peach
Cod. 03
S 2010 Y70R

 Burro
Butter
Cod. 04
RAL 1015

 Cielo
Sky
Cod. 05
S 1510-B

 Seta
Silk
Cod. 06
RAL 7044

 Oceano
Ocean
Cod. 07
RAL 5005

 Foglia
Leaf
Cod. 08
RAL 6024

 Argilla
Clay
Cod. 09
RAL 1011

 Fuoco
Fire
Cod. 10
RAL 3000

 Rosa Fluo
Fluorescent Pink
Cod. 11

 Verde Fluo
Fluorescent Green
cod 12

 Giallo Fluo
Fluorescent Yellow
Cod. 13

 Rosso Fluo
Fluorescent Red
Cod. 14

 Trasparente opaco
Matt Transparent

 Colori su richiesta
Colours on request

Essenze
Woods

 Noce Canaletto
Black Walnut

 Multistrato di Betulla
placcato laminato
Laminated Birch
Plywood

Materiali
Materials

 Acciaio super mirror Cromo
Super mirror steel Chrome

 Acciaio super mirror Oro 24 kt
Super mirror steel Gold 24 kt

 Lamiera di ferro laminata a caldo*
Hot rolled iron plate*

 Acciaio Corten* (su richiesta)
Corten steel* (on request)

 Acciaio brunito (su richiesta)
Burnished steel (on request)